

Redundant & Power Combined System Product Range



**Europe's dedicated satellite amplifier manufacturer
and equipment specialist**

www.space-path.com

Universal Outdoor TWTA Redundant Systems



SpacePath offers fully integrated 1:1, 1:2, 1:N redundant and power combined systems for use with its indoor and outdoor amplifiers. All amplifier models in the STA4000/5000 series, within a single operating band, can be accommodated within the same system to provide lower cost of ownership and cost-effective upgrades combined with maximum flexibility.

Modular rack-mount system

A universal rack mounting system enables simplified installation in hard to reach spaces. The light-weight, modular rack design also enables installation by a single person. Simply remove the amplifier from its shipping container, install a single mounting bracket and slide into the system rack. Each amplifier is locked down and connected with the quick-release waveguide connector. Once fitted and connected to a power source the amplifier is ready for software-based configuration and available for use.



The flexibility of the modular rack mount design enables easy upgrades from a standard redundant system to 1:2 redundant systems. Upgrade kits are available for providing additional output components and hardware.

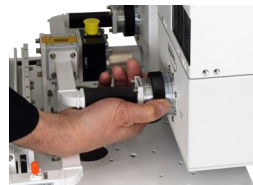

Phase combined and redundancy can be offered in any configuration.



Fully assembled rack-mount system

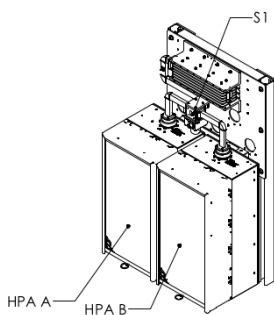

1:1 Redundant system

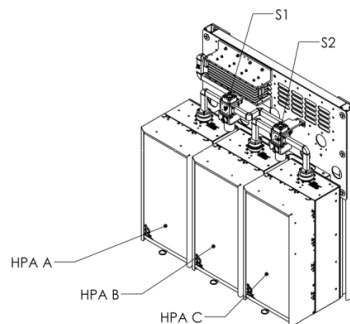

1:2 Redundant system

Indoor TWTA Redundant Systems



Indoor redundant amplifier systems are supported with air inlet/exhaust air cowls, waveguide switches, dummy load, interconnecting waveguides and cabling. System control is from the front panel touch screen.

Systems can be configured in 1:1, 1:2 or 1:N operation and as power combined systems. Optional cabinet enclosures are also available.

Remote system monitoring and control is also provided by web browser GUI via the Ethernet port.

Redundant & Power Combined Systems

SpacePath Communications provides complete indoor and outdoor redundant and power combined systems. Each system is fully tested and easy to assemble.

Quick-release waveguide connectors are also optionally available.

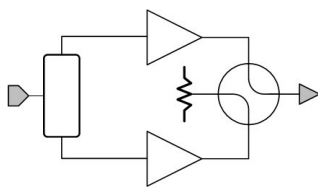

1:1 Redundant Systems

Comprising two amplifiers, indoor controller, cable harness (connecting amplifiers, waveguide switch to indoor controller), external waveguide network, load and waveguide switch.

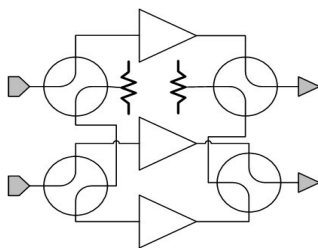

1:2 Redundant Systems

Comprising three amplifiers, touch screen indoor controller, cable harness (connecting amplifiers, waveguide switches to indoor controller), external waveguide network, loads and waveguide switches.

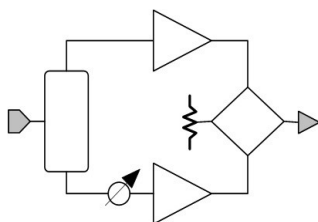

Power Combined Systems

The standard two amplifier power combined system comprises two amplifiers, indoor controller, cable harness (connecting amplifiers, combiner/switch to indoor controller), external waveguide network, combiner, phase adjuster, load and waveguide switch.

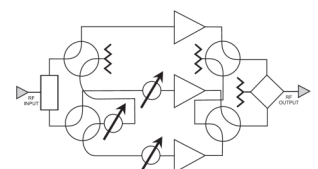

1:2 Power Combined Systems

Comprising three amplifiers, with two amplifiers power combined and the third providing the redundant support for the combined system. The system includes waveguide network, combiner, phase adjusters, switches, loads, inter-connecting cabling and full control features.

Controllers



SPC1U01 Control Unit

The SPC1U01 controller is a compact and user-friendly unit for single thread and two-amplifier control. It provides complete monitoring and control over the 1:1 system along with each of the amplifiers. Further monitoring and control is also provided by web browser via the Ethernet port.



SPC3U01 Control Unit

The SPC3U01 controller is a compact and user-friendly touch screen unit for use in a SpacePath 1:2 redundant system. The unit provides complete monitoring and control over the 1:2 system along with each of the amplifiers. Further monitoring and control is also provided by web browser via the Ethernet port.

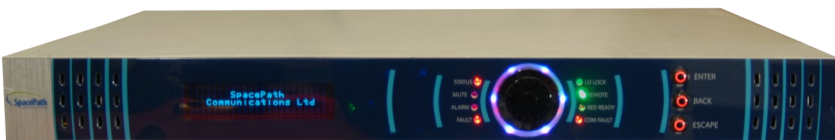

SPC1100 Control Unit for SSPA/SSPB Products

The SPC1100 controller is a compact and user-friendly unit providing full remote control for one or two SpacePath solid-state amplifiers (SSPA/SSPB). Further monitoring and control is also provided by web browser via the Ethernet port. The controller can also be supplied as part of a complete redundant package which includes the waveguide and coaxial inter-connects between amplifiers, mounting hardware and cabling.

Setting new standards in customer-driven innovation and performance

SpacePath Communications designs, manufactures and distributes an expanding range of innovative satellite uplink amplifiers and associated equipment, including RF high-power amplifiers (HPA), solid-state amplifiers (SSPA/SSPB), redundant system controllers and sub-systems.



SpacePath Communications Ltd.
Unit 4, Bartley Point, Osborn Way, Hook, Hampshire, RG27 9GX, UK.
Tel: +44 1256 760525 Email: sales@space-path.com
www.space-path.com